

## Features

- High Efficiency (Up to 92%)
- Full Power at 50-100% Max Current (Constant Power)
- DALI Dimmable and Dim-to-Off
- Standby Power  $\leq 1$  W
- Input Surge Protection: 4kV line-line, 6kV line-earth
- All-Around Protection: OVP, SCP, OTP
- Waterproof (IP67)
- SELV Output
- Suitable for Independent Use

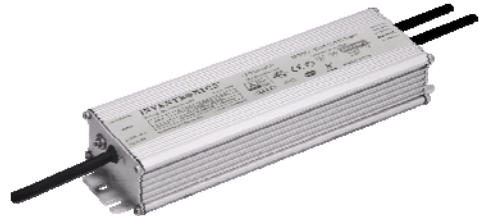

## Description

The EUD-150SxxxBV series is a 150W, constant-current, programmable LED driver that operates from 90-305 Vac input with excellent power factor. Created for high bay, tunnel and roadway lights, it provides a dim-to-off mode with low standby power. The high efficiency of these drivers and compact metal case enables them to run cooler, significantly improving reliability and extending product life. To ensure trouble-free operation, protection is provided against input surge, output over voltage, short circuit, and over temperature.

## Models

Output Current Range	Full-Power Current Range (1)	Default Output Current	Input Voltage Range(2)	Output Voltage Range	Max. Output Power	Typical Efficiency (3)	Power Factor		Model Number (4)
							120Vac	220Vac	
65-1300mA	650-1300mA	700 mA	90~305 Vac/ 127~250 Vdc	69~230Vdc	150 W	92.0%	0.99	0.96	EUD-150S130BV
130-2600mA	1300-2600mA	2100 mA	90~305 Vac/ 127~250 Vdc	35~115Vdc	150 W	91.5%	0.99	0.96	EUD-150S260BV
260-5200mA	2600-5200mA	4200 mA	90~305 Vac/ 127~250 Vdc	18 ~ 58Vdc	150 W	90.5%	0.99	0.96	EUD-150S520BV (SELV)

- Notes:** (1) Output current range with constant power at 150W  
 (2) Certified input voltage range: 100-240Vac or 127-250Vdc (except CCC and KS)  
 (3) Measured at a 220Vac input with 100% maximum output current and 50% maximum output voltage.  
 (4) All the models are certificated to KS, except EUD-150S130BV

## I-V Operating Area

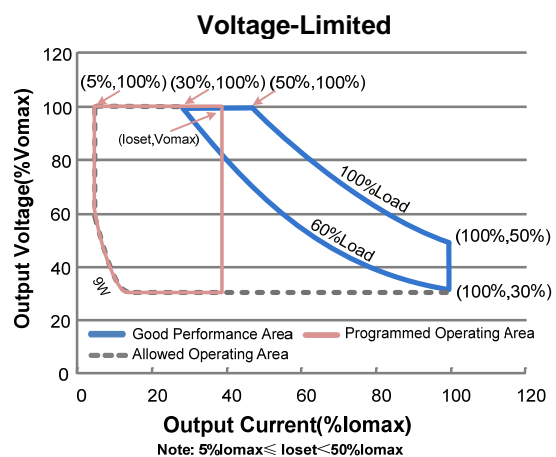
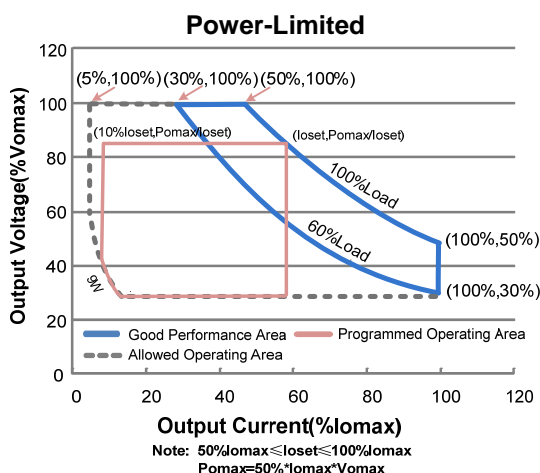

## Representative in Hungary:

**HOLUX**  
VILÁGÍTÁS ÉS VILLAMOSSÁG

HOLUX Kft. H-1135 Budapest, Béke u. 51-55.  
 Tel: (06 1) 450 2700 Fax: (06 1) 450 2710  
 www.holux.hu www.fenyaruhasz.hu e-mail: hosoo@holux.hu

## Input Specifications

Parameter	Min.	Typ.	Max.	Notes
Input Voltage	90 Vac	-	305 Vac	127~250 Vdc
Input Frequency	47 Hz	-	63 Hz	
Leakage Current	-	-	0.70 mA	IEC60598-1; 240Vac/ 60Hz
Input AC Current	-	-	1.8 A	Measured at full load and 100 Vac input.
	-	-	0.85 A	Measured at full load and 220 Vac input.
Inrush Current(I <sup>2</sup> t)	-	-	1.4 A <sup>2</sup> s	At 220Vac input, 25°C Cold Start, Duration=1.46 mS, 10%Ipk-10%Ipk. See Inrush Current Waveform for the details.
PF	0.90	-	-	At 100-277Vac, 60%-100% Load (90-150W)
THD	-	-	20%	

## Output Specifications

Parameter	Min.	Typ.	Max.	Notes
Output Current Tolerance	-5%loset	-	5%loset	At full load condition
Output Current Setting(loset) Range	5%lomax	-	100%lomax	
Output Current Setting Range with Constant Power	50%lomax	-	100%lomax	
Total Output Current Ripple (pk-pk)	-	5%lomax	10%lomax	At full load condition, 20 MHz BW
Output Current Ripple at < 200 Hz (pk-pk)	-	2%lomax	-	At full load condition. Only this component of ripple is associated with visible flicker.
Startup Overshoot Current	-	-	10%lomax	At full load condition
No Load Output Voltage	-	-	-	
EUD-150S130BV	-	-	275V	
EUD-150S260BV	-	-	138V	
EUD-150S520BV	-	-	70V	
Line Regulation	-	-	±0.5%	Measured at full load
Load Regulation	-	-	±1.5%	
Turn-on Delay Time	-	0.8 s	1.5 s	Measured at 120Vac and 220Vac input.
Temperature Coefficient of loset	-	-	0.03%/°C	Case temperature = 0°C ~Tc max

**Note:** All specifications are typical at 25°C unless otherwise stated.

## General Specifications

Parameter	Min.	Typ.	Max.	Notes
Efficiency at 120 Vac input: EUD-150S130BV Io=650 mA Io=1300 mA EUD-150S260BV Io=1300 mA Io= 2600mA EUD-150S520BV Io= 2600mA Io= 5200mA	86.0% 87.0% 86.5% 86.5% 86.5% 85.5%	89.0% 90.0% 89.5% 89.5% 89.5% 88.5%	- - - - - -	Measured at full load and steady-state temperature in 25°C ambient; (Efficiency will be about 2.0% lower if measured immediately after startup.)
Efficiency at 220 Vac input: EUD-150S130BV Io=650 mA Io=1300 mA EUD-150S260BV Io=1300 mA Io= 2600mA EUD-150S520BV Io= 2600mA Io= 5200mA	89.0% 90.0% 89.5% 89.5% 89.5% 88.5%	91.0% 92.0% 91.5% 91.5% 91.5% 90.5%	- - - - - -	Measured at full load and steady-state temperature in 25°C ambient; (Efficiency will be about 2.0% lower if measured immediately after startup.)
Efficiency at 277 Vac input: EUD-150S130BV Io=650 mA Io=1300 mA EUD-150S260BV Io=1300 mA Io= 2600mA EUD-150S520BV Io= 2600mA Io= 5200mA	89.5% 90.5% 89.5% 90.0% 89.5% 89.0%	91.5% 92.5% 91.5% 92.0% 91.5% 91.0%	- - - - - -	Measured at full load and steady-state temperature in 25°C ambient; (Efficiency will be about 2.0% lower if measured immediately after startup.)
Standby power	-	-	1 W	Measured at 230Vac/50Hz; Dimming off
MTBF	-	236,000 Hours	-	Measured at 220Vac input, 80%Load and 25°C ambient temperature (MIL-HDBK-217F)
Lifetime	-	120,000 Hours	-	Measured at 220Vac input, 80%Load and 60°C case temperature; See lifetime vs. Tc curve for the details
Operating Case Temperature for Safety Tc_s	-40°C	-	+89°C	
Operating Case Temperature for Warranty Tc_w	-40°C	-	+70°C	
Storage Temperature	-40°C	-	+85°C	Humidity: 5%RH to 100%RH
Dimensions Inches (L × W × H) Millimeters (L × W × H)		8.62× 2.66 × 1.56 219 × 67.5 × 39.5		With mounting ear 9.67 × 2.66 × 1.56 246 × 67.5 × 39.5
Net Weight	-	1210 g	-	

**Note:** All specifications are typical at 25°C unless otherwise stated.

## Dimming Specifications

Parameter	Min.	Typ.	Max.	Notes
DA1,DA2 High Level	9.5V	16V	22.5V	
DA1,DA2 Low Level	-6.5V	0V	6.5V	
DA1,DA2 Current	0mA	-	2mA	
Dimming Output Range	10%I <sub>o</sub> set	-	I <sub>o</sub> set	50%I <sub>o</sub> max ≤ I <sub>o</sub> set ≤ 100%I <sub>o</sub> max
	5%I <sub>o</sub> max	-	I <sub>o</sub> set	5%I <sub>o</sub> max ≤ I <sub>o</sub> set < 50%I <sub>o</sub> max

**Note:** All specifications are typical at 25 °C unless stated otherwise.

## Standards Compliance

Safety Category	Standard
CE	EN 61347-1, EN61347-2-13
KS	KS C 7655 : 2011
EMI Standards	Notes
EN 55015 <sup>(1)</sup>	Conducted emission Test & Radiated emission Test
EN 61000-3-2	Harmonic current emissions
EN 61000-3-3	Voltage fluctuations & flicker
EMS Standards	Notes
EN 61000-4-2	Electrostatic Discharge(ESD): 8kV air discharge, 4kV contact discharge
EN 61000-4-3	Radio-Frequency Electromagnetic Field Susceptibility Test-RS
EN 61000-4-4	Electrical Fast Transient/Burst-EFT
EN 61000-4-5	Surge Immunity Test: AC Power Line: line to line 4kV, line to earth 6kV <sup>(2)</sup>
EN 61000-4-6	Conducted Radio Frequency Disturbances test-CS
EN 61000-4-8	Power Frequency Magnetic Field Test
EN 61000-4-11	Voltage Dips
EN 61547	Electromagnetic Immunity Requirements Applies To Lighting Equipment
DALI Standards	Notes
DALI	IEC62386-101,102 & part of 207 <sup>(3)</sup>

**Note:** (1) This LED driver meets the EMI specifications above, but EMI performance of a luminaire that contains it depends also on the other devices connected to the driver and on the fixture itself.

(2) To perform electric strength (hi-pot) testing, the “GDT ground disconnect” (nut and metal lock sheet) on the driver end-cap should be removed temporarily to prevent the internal gas discharge tube from conducting (as allowed by IEC 60598-1 Clause 10.2). After testing is completed, these items must be reinstalled to restore line-to-earth surge protection and secure the end cap.

(3) Optional Commands Implemented: 243 (query open circuit)

## Lifetime vs. Case Temperature

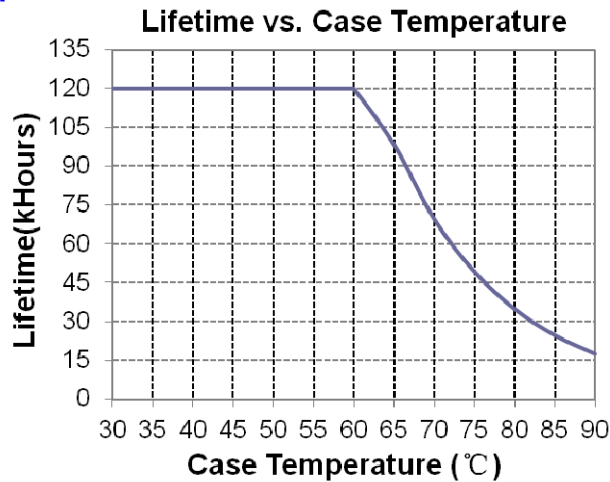

## Inrush Current Waveform

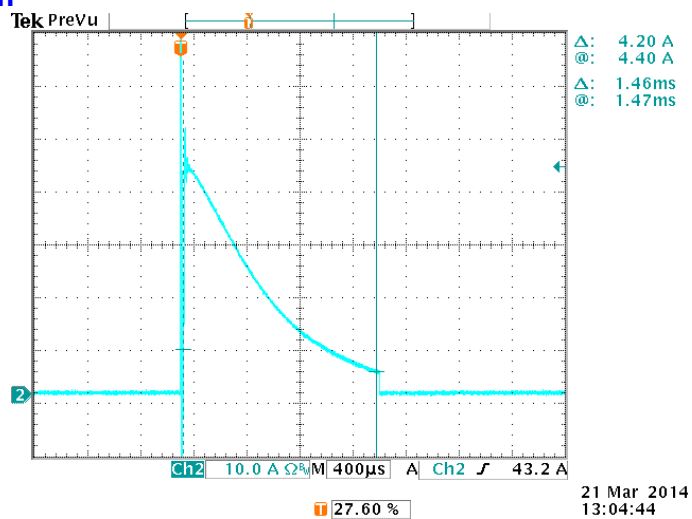

## Efficiency vs. Load

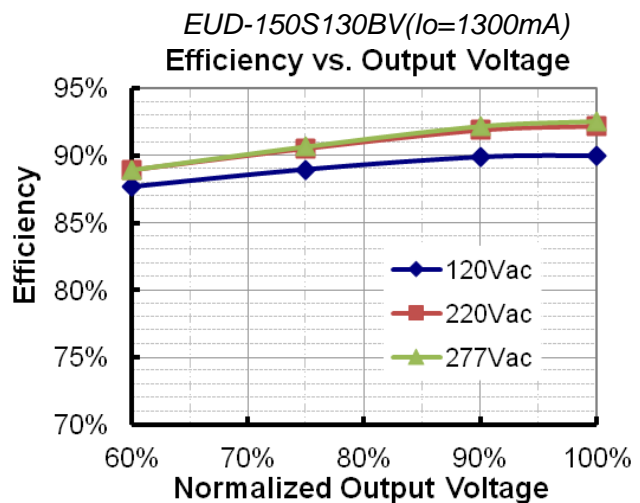
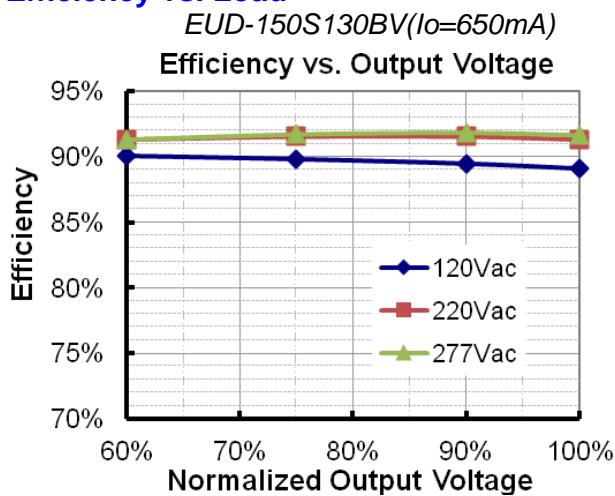

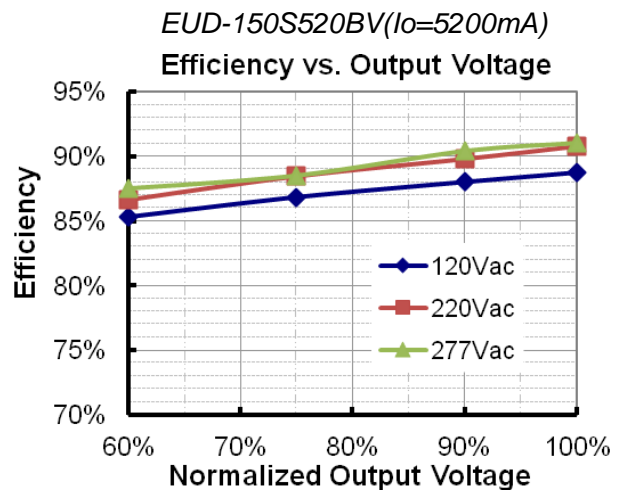
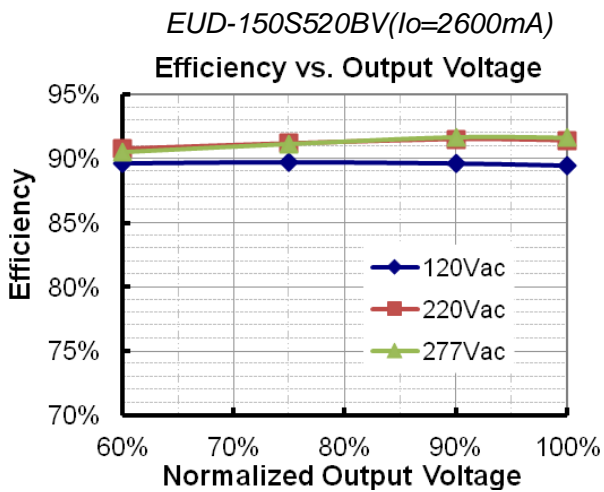
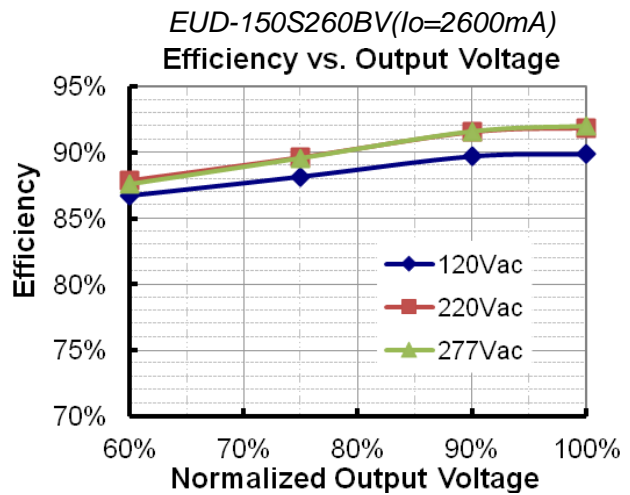
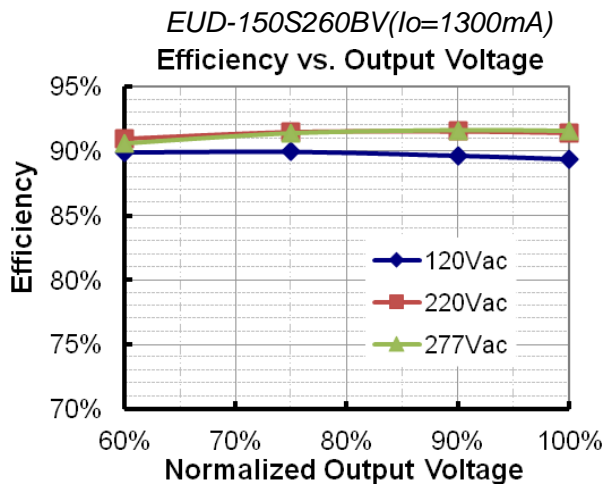

## Power Factor

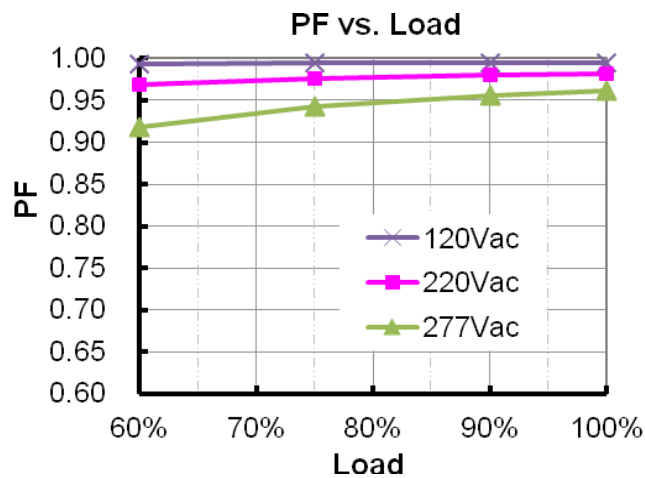

## Total Harmonic Distortion

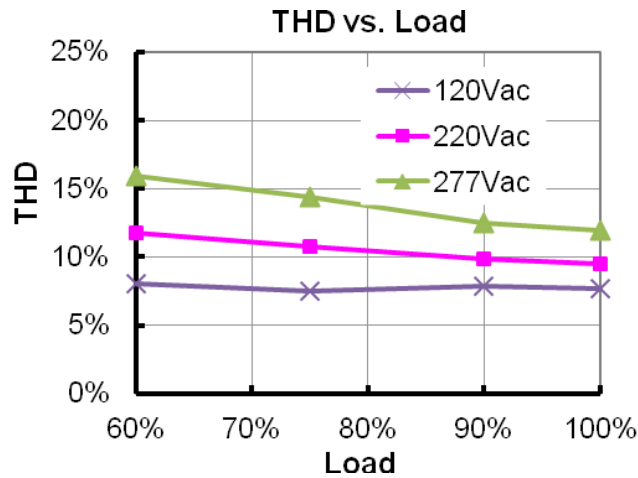

## Protection Functions

Parameter	Notes
Over Temperature Protection	Decreases output current, returning to normal after over temperature is removed.
Short Circuit Protection	Auto Recovery. No damage will occur when any output is short circuited. The output shall return to normal when the fault condition is removed.
Over Voltage Protection	Limits output voltage at no load and in case the normal voltage limit fails.

## Dimming

### ● DALI Dimming

The recommended implementation of the dimming control is provided below.

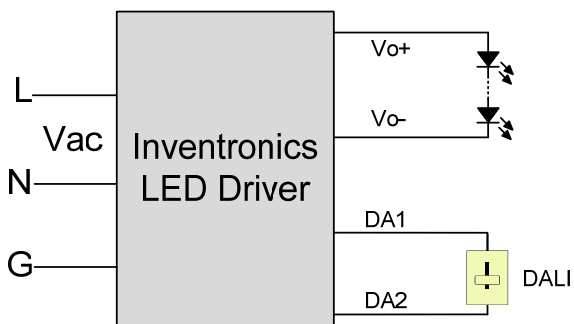



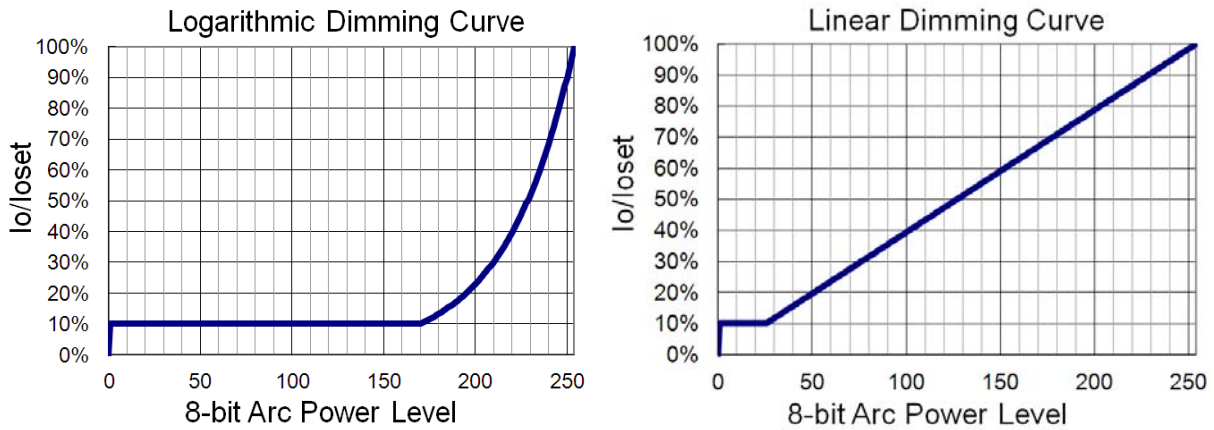

Implementation: DALI Dimming

## Programming Connection Diagram

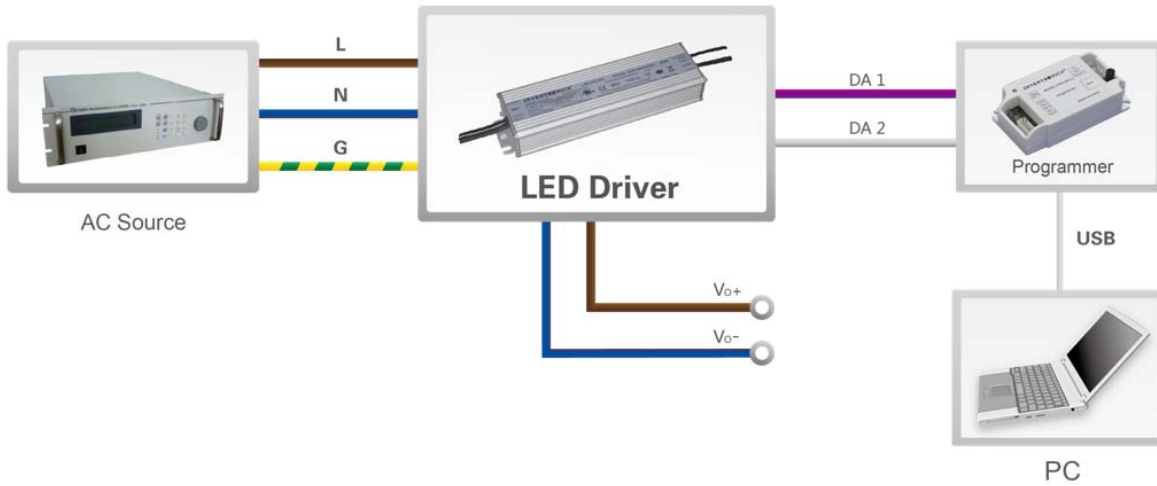

**Note:** The driver needs to be powered on during the programming process.

- Please refer to [PRG-MUL2](#) Multi-Programmer datasheet for details.



## Mechanical Outline

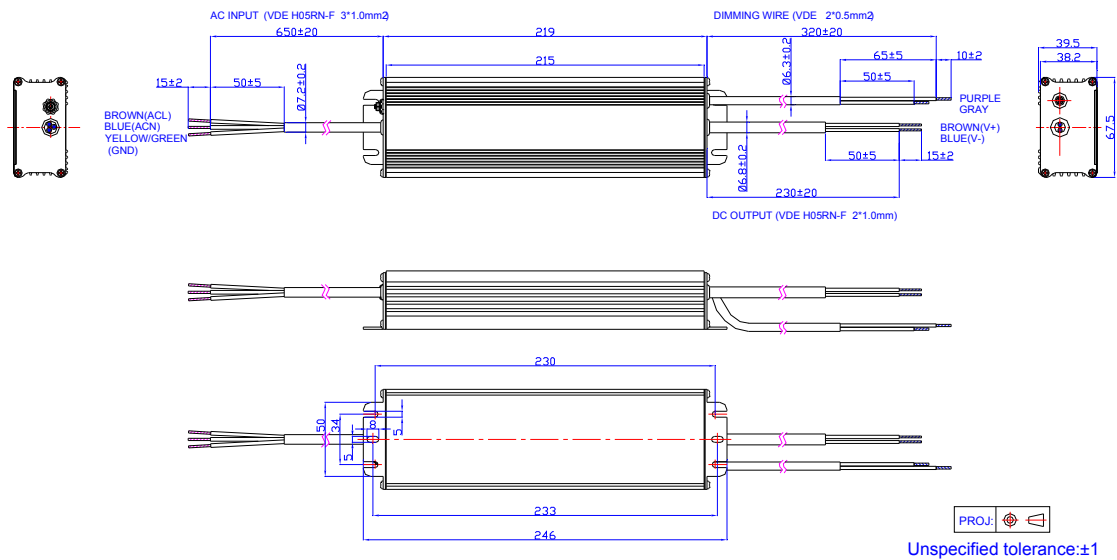

## RoHS Compliance

Our products comply with the European Directive 2011/65/EC, calling for the elimination of lead and other hazardous substances from electronic products.

## Revision History

Change Date	Rev.	Description of Change		
		Item	From	To
2015-03-13	A	Datasheets Release	/	/
2015-06-01	B	Description	/	Update
		Models	/	Update
		Mechanical Outline	/	Update
2015-09-16	C	KS, DALI Logo	/	Added
		Features	/	Update
		Safety & EMC Compliance	Safety & EMC Compliance	Standards Compliance
		Standards Compliance	DALI Standards	Added
2016-04-13	D	General Specifications	With mounting ear	Added
		General Specifications	Net Weight	Update
		Standards Compliance	/	Update